

CODE: P01

STATIC TEST

sw: AQ2TB-STATICAUT

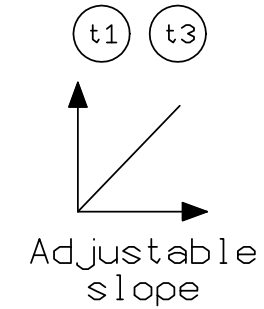
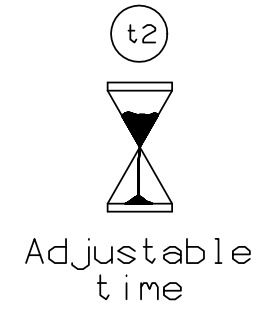
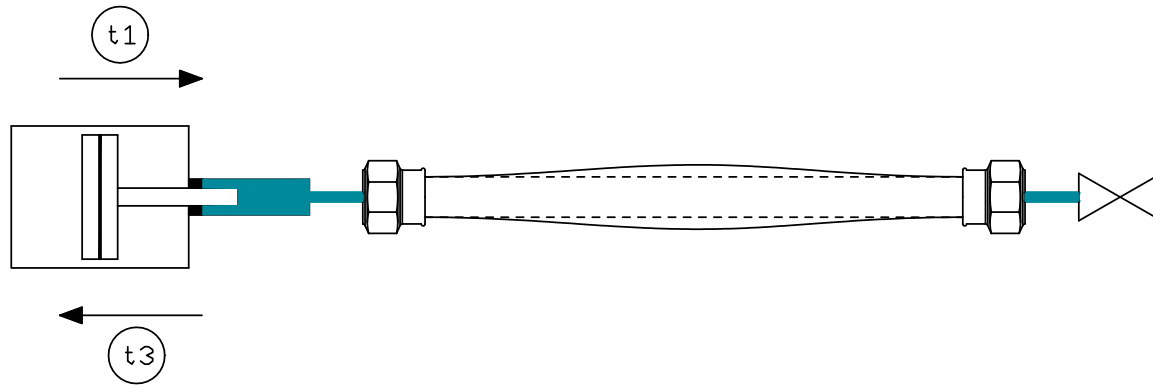
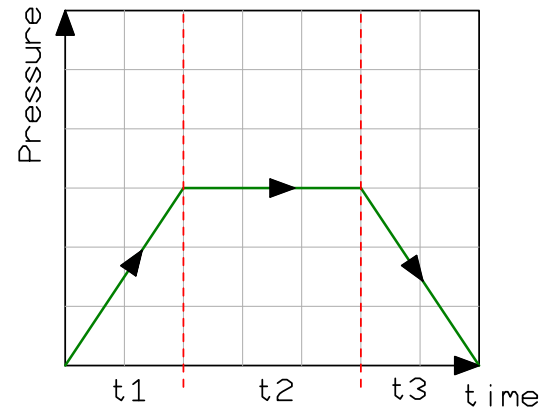

PRESSURE OPERATING RANGE

BASE MODEL: 150 bar

EXTENSION TO: 250 / 400 / 800 bar

CODE: P02

PULSING TEST

sw: AQ2TB-PULSEAUT

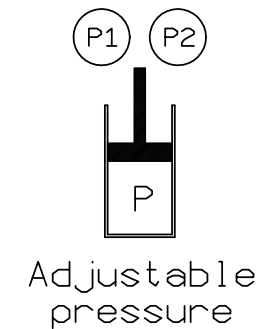
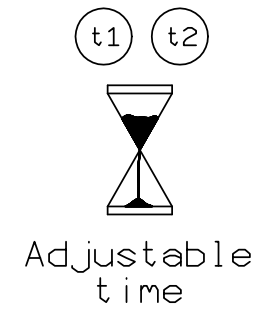
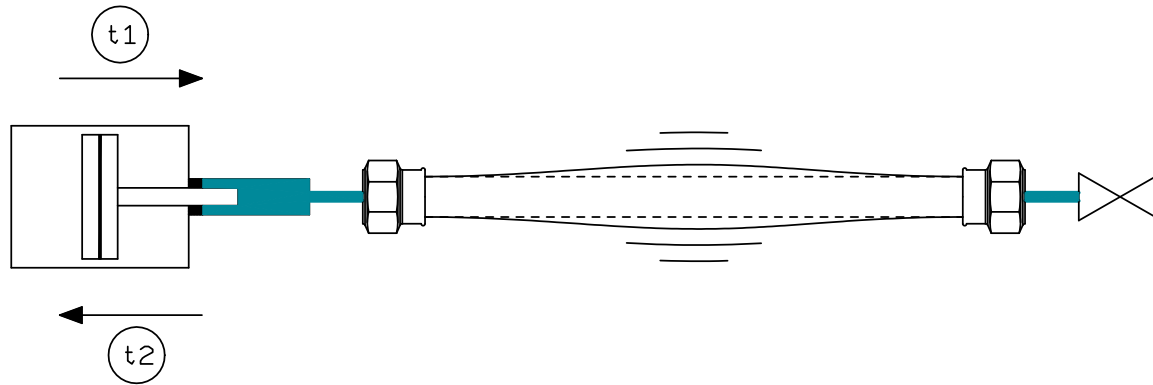
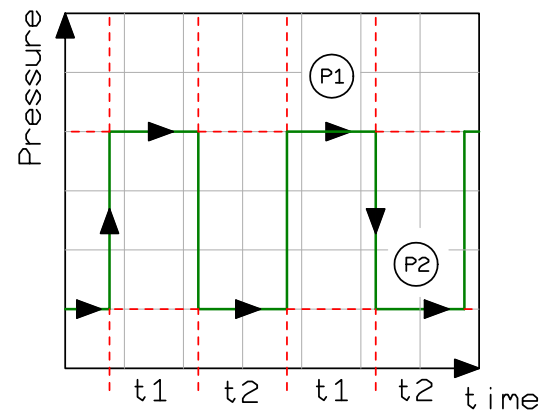

PRESSURE OPERATING RANGE

BASE MODEL: 150 bar

EXTENSION TO: 250 / 400 bar

CODE: P03

CYCLING TEST

sw: AQ2TB-PULSEAUT

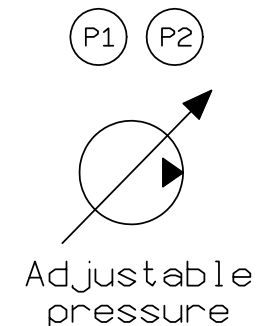
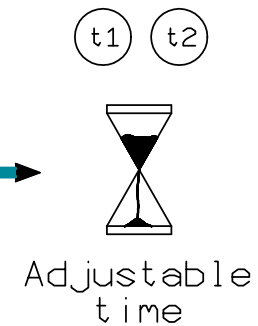
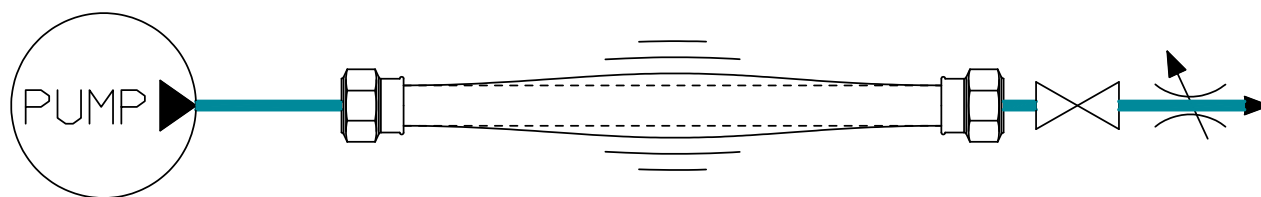
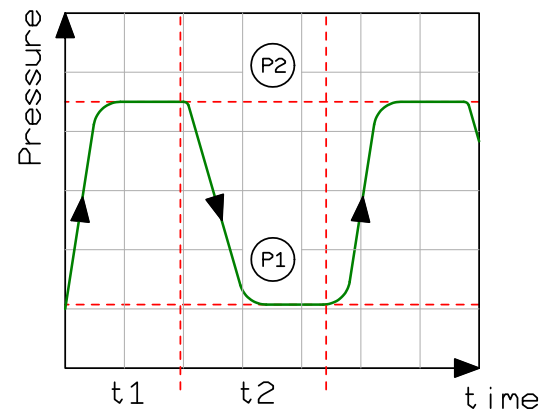

PRESSURE OPERATING RANGE

BASE MODEL: 10 bar

EXTENSION TO: 20 bar

CODE: P04

BURST TEST

sw: AQ2TB-STATICAUT

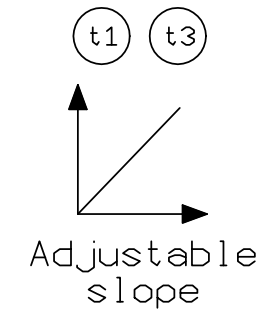
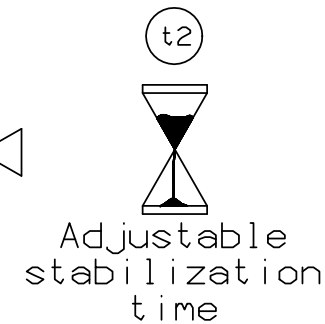
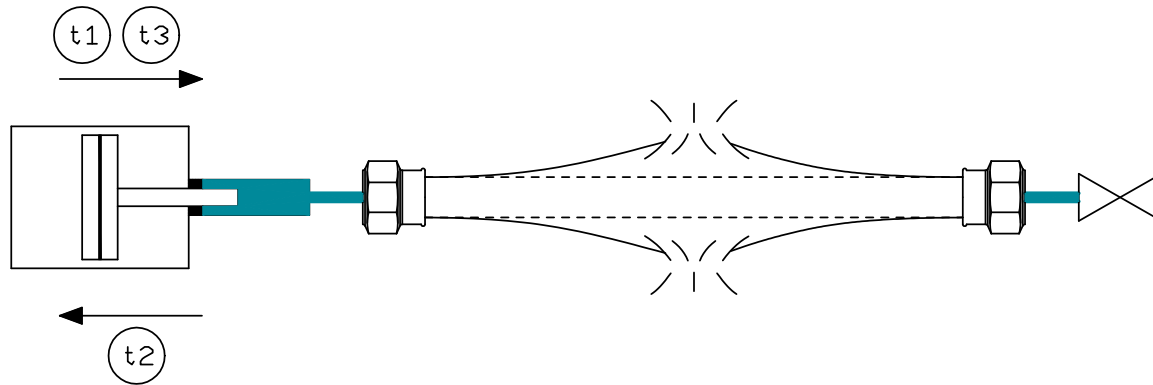
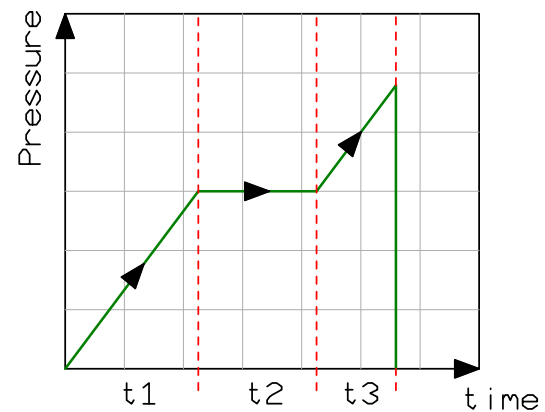

PRESSURE OPERATING RANGE

BASE MODEL: 150 bar

EXTENSION TO: 250 / 400 / 800 bar

CODE: PT01

STATIC TEST

sw: AQ2TB-STATICAUT

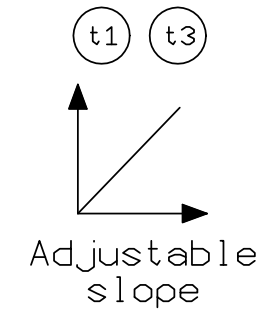
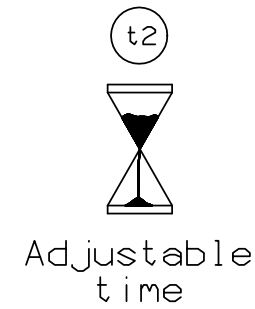
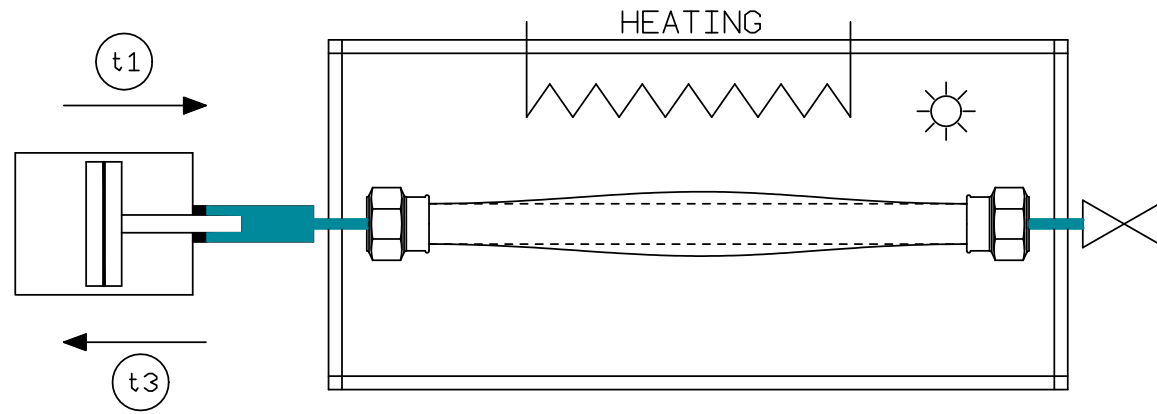
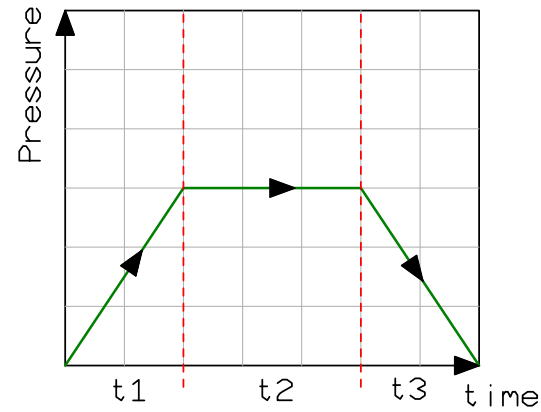

PRESSURE OPERATING RANGE  
BASE MODEL: 150 bar  
EXTENSION TO: 250 / 400 / 800 bar  
WATER TEMPERATURE: Room Temp.

CODE: PT02

PULSING TEST

sw: AQ2TB-PULSEAUT

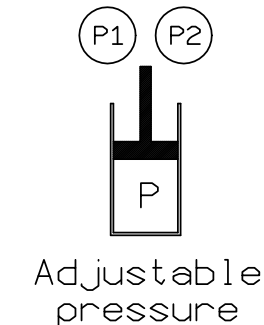
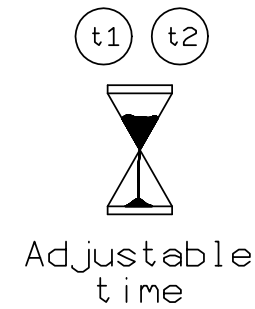
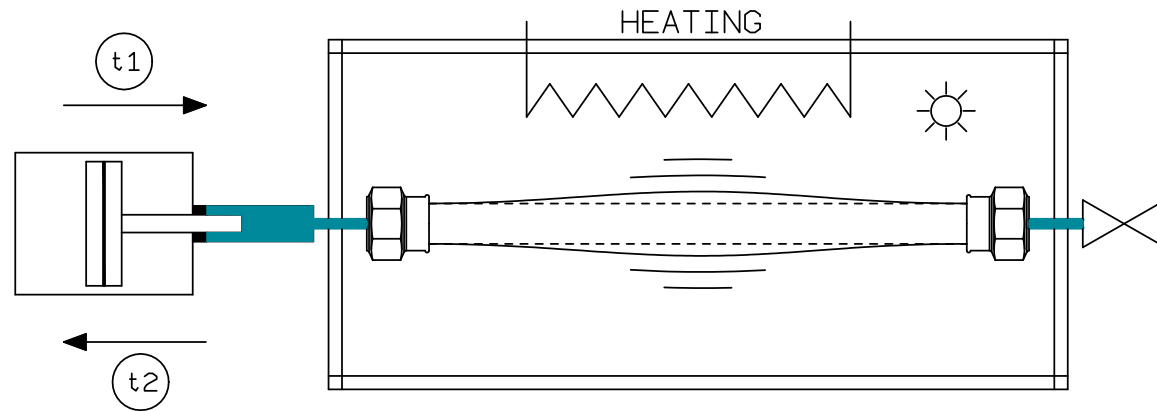
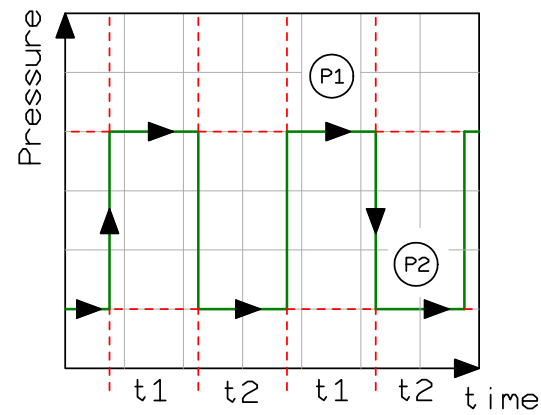

PRESSURE OPERATING RANGE  
BASE MODEL: 150 bar  
EXTENSION TO: 250 / 400 bar  
WATER TEMPERATURE: Room Temp.

CODE: PT03

CYCLING TEST

sw: AQ2TB-PULSEAUT

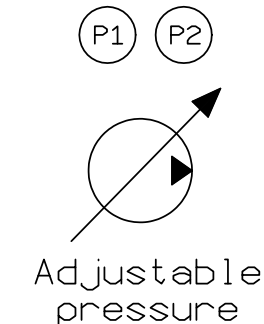
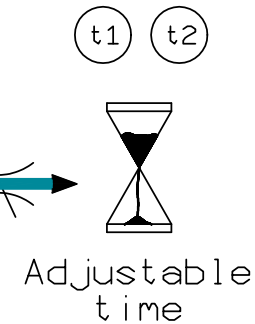
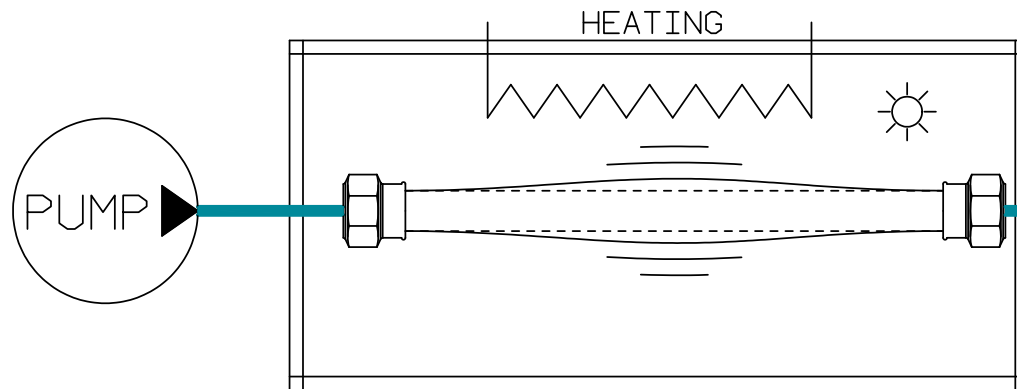
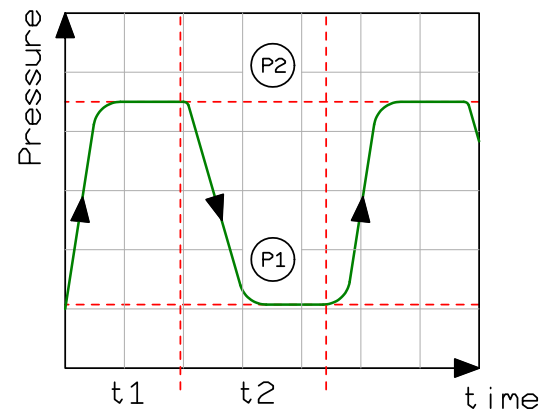

PRESSURE OPERATING RANGE  
BASE MODEL: 10 bar  
EXTENSION TO: 20 bar  
WATER TEMPERATURE: Room Temp.

CODE: PT04

BURST TEST

sw: AQ2TB-STATICAUT

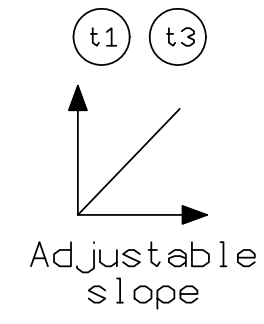
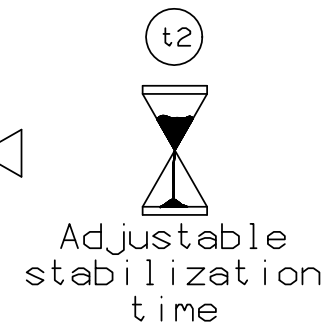
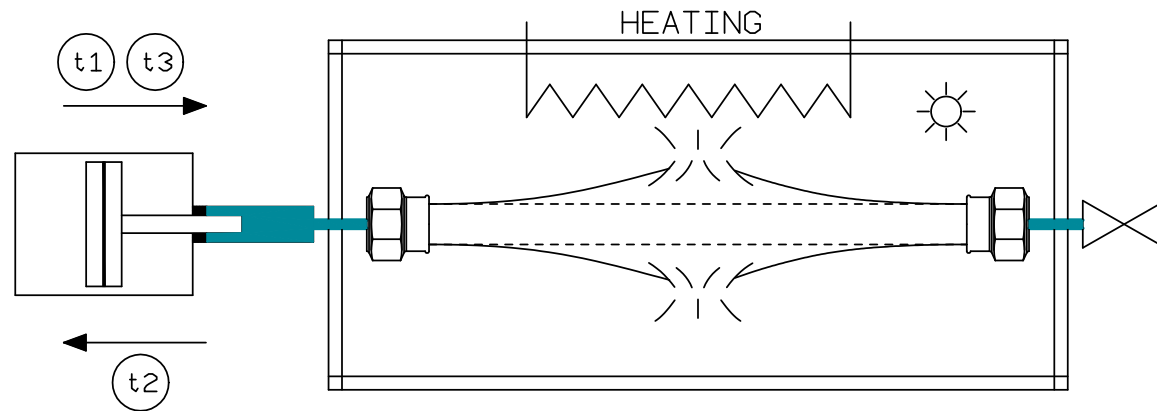
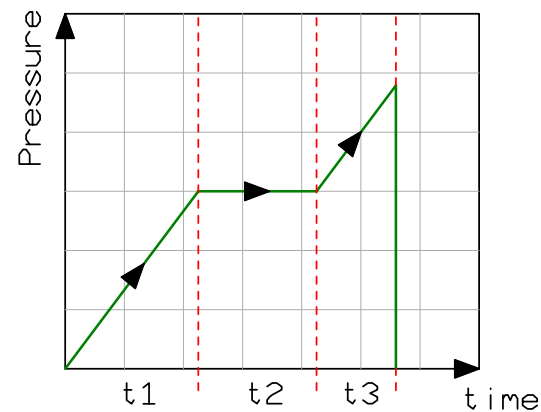

PRESSURE OPERATING RANGE  
BASE MODEL: 150 bar  
EXTENSION TO: 250 / 400 / 800 bar  
WATER TEMPERATURE: Room Temp.

CODE: PT01H

STATIC TEST

sw: AQ2TB-STATICAUT

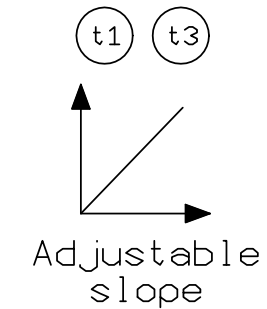
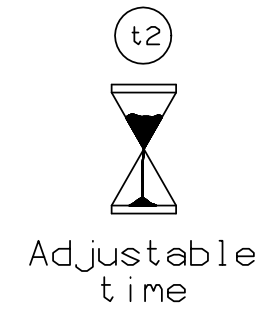
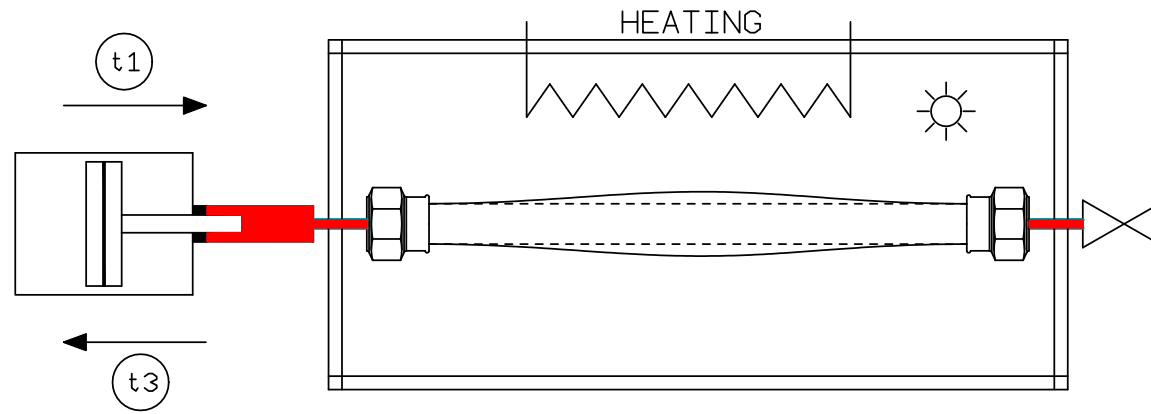
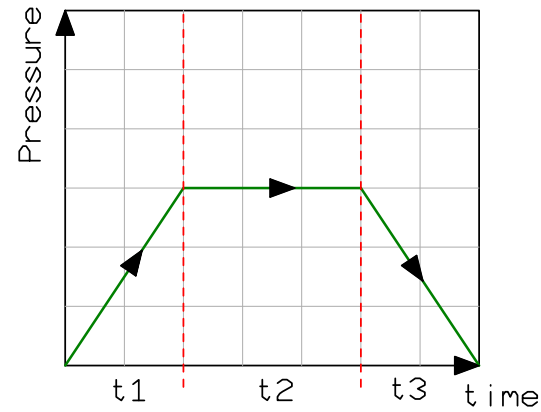

PRESSURE OPERATING RANGE  
BASE MODEL: 150 bar  
EXTENSION TO: 250 / 400 / 800 bar  
ADJUSTABLE WATER TEMPERATURE:  
up to 95 °C

CODE: PT02H

PULSING TEST

sw: AQ2TB-PULSEAUT

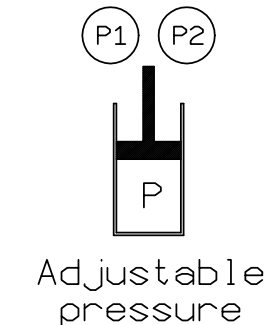
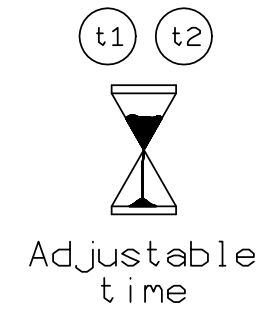
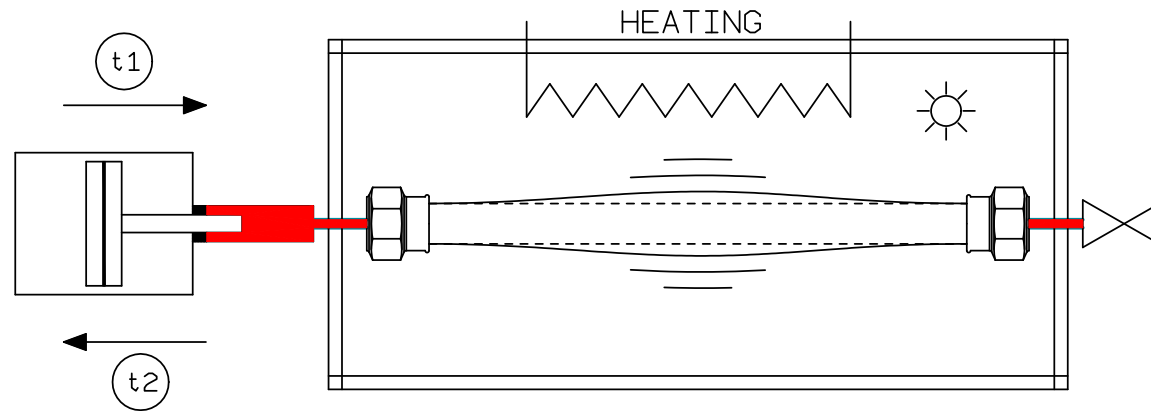
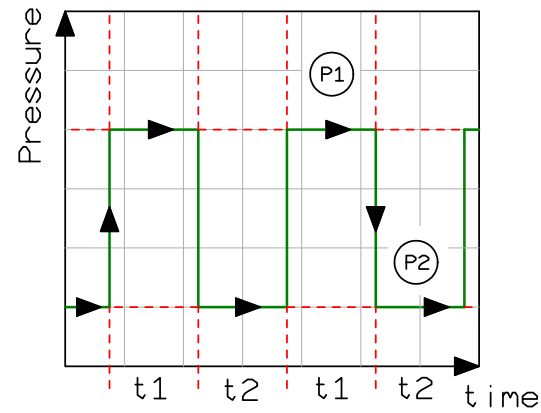

PRESSURE OPERATING RANGE  
BASE MODEL: 150 bar  
EXTENSION TO: 250 / 400 bar  
ADJUSTABLE WATER TEMPERATURE:  
up to 95 °C

CODE: PT03H

CYCLING TEST

sw: AQ2TB-PULSEAUT

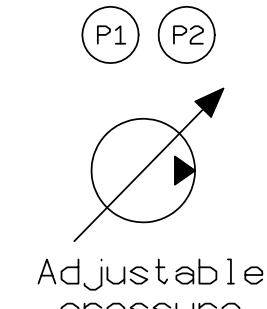
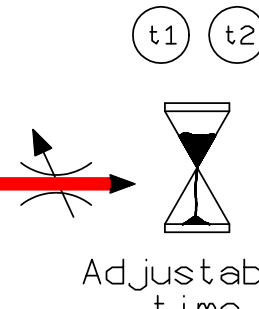
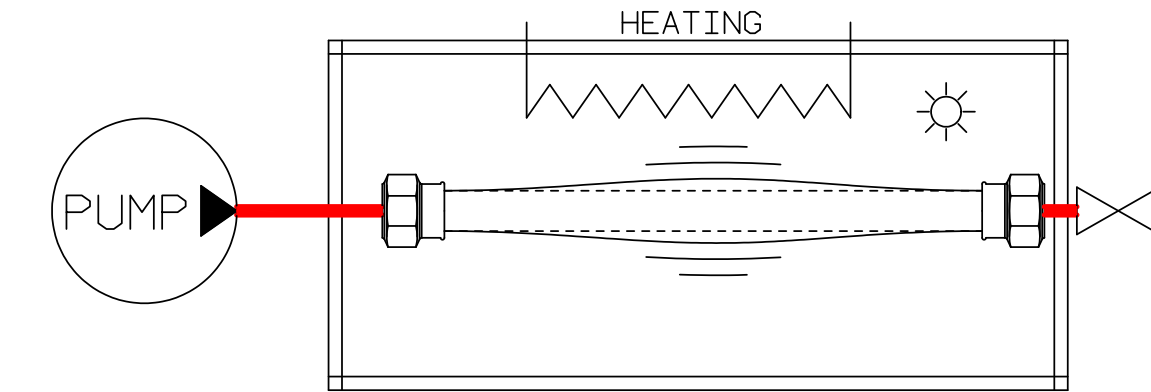
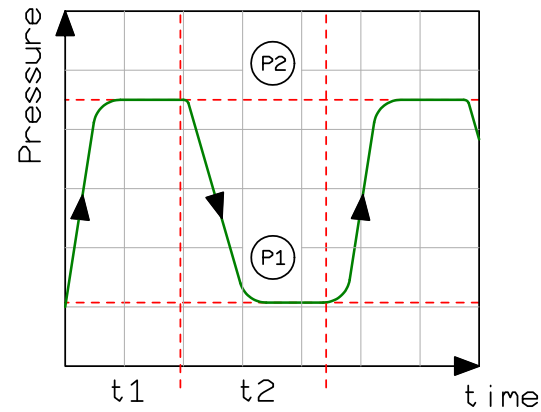

PRESSURE OPERATING RANGE  
BASE MODEL: 10 bar  
EXTENSION TO: 20 bar  
ADJUSTABLE WATER TEMPERATURE:  
up to 95 °C

CODE: PT04H

BURST TEST

sw: AQ2TB-STATICAUT

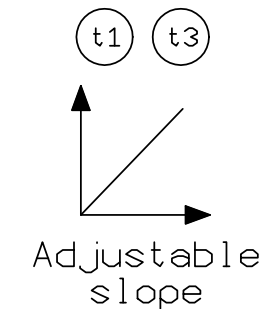
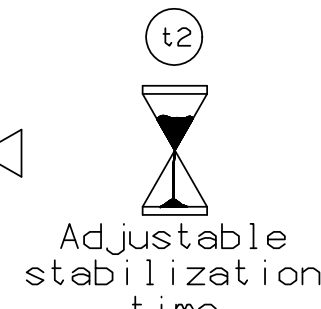
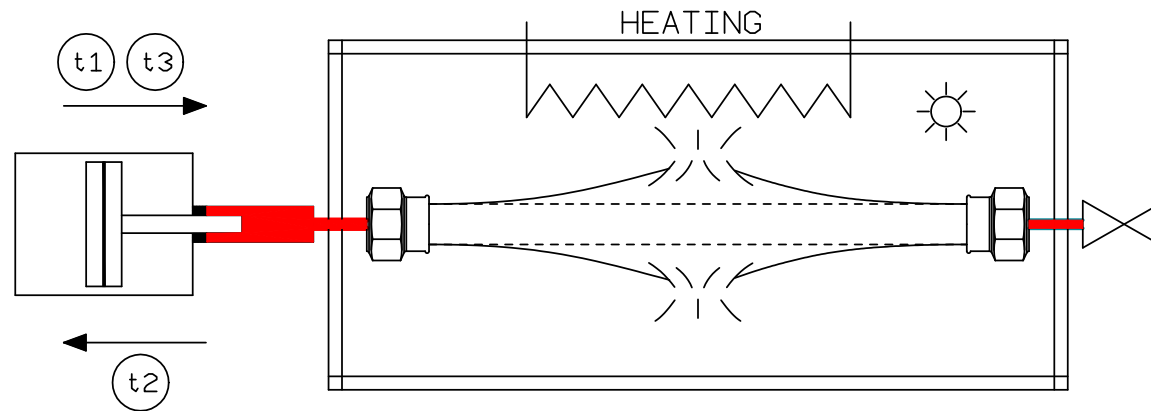
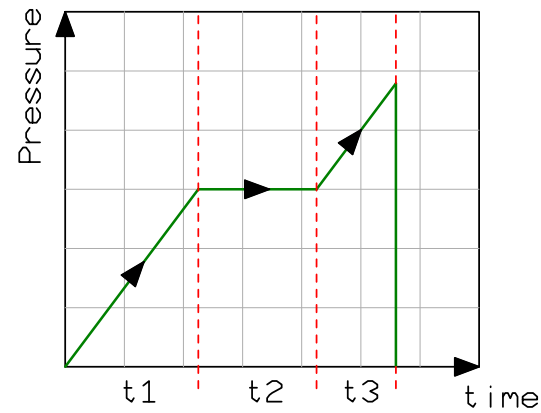

PRESSURE OPERATING RANGE  
BASE MODEL: 150 bar  
EXTENSION TO: 250 / 400 / 800 bar  
ADJUSTABLE WATER TEMPERATURE:  
up to 95 °C

CODE: P01-HC

STATIC TEST WITH HOT WATER CIRCULATION

sw: AQ2TB-\*

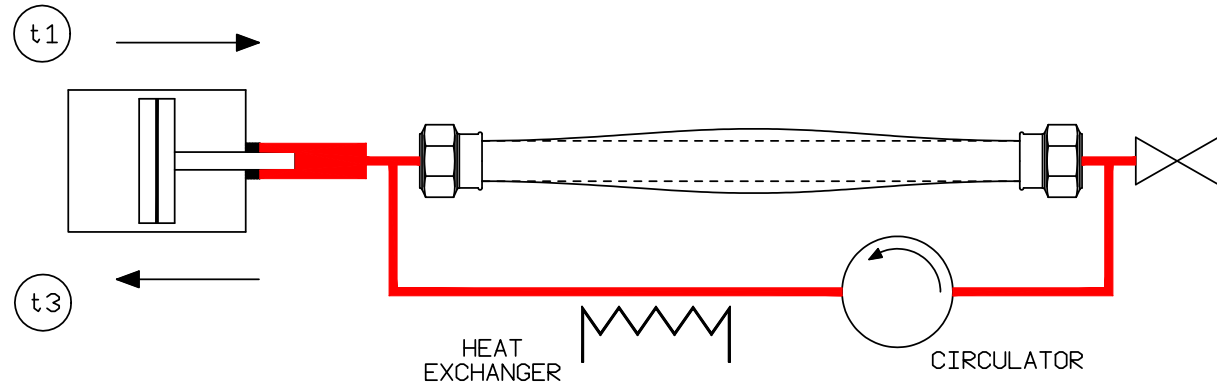
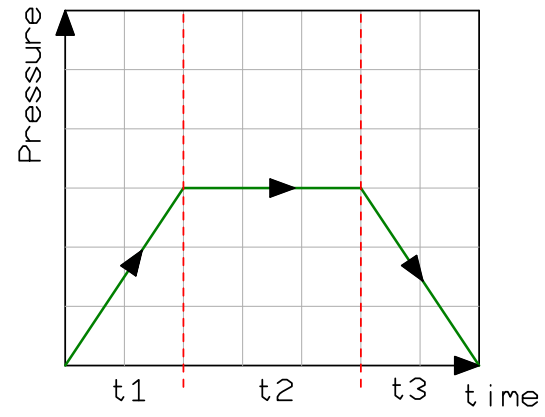

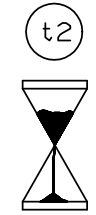
  
 Adjustable  
 time

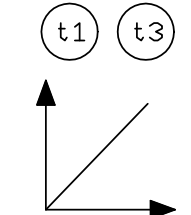
  
 Adjustable  
 slope

PRESSURE OPERATING RANGE

BASE MODEL: 150 bar

EXTENSION TO: 250 / 400 / 800 bar

CODE: P04-HC

BURST TEST WITH HOT WATER CIRCULATION

sw: AQ2TB-\*

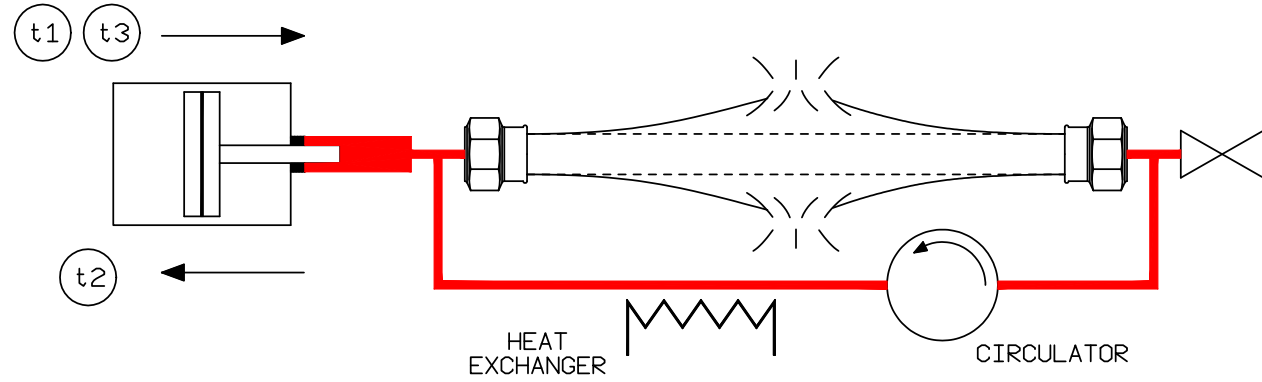
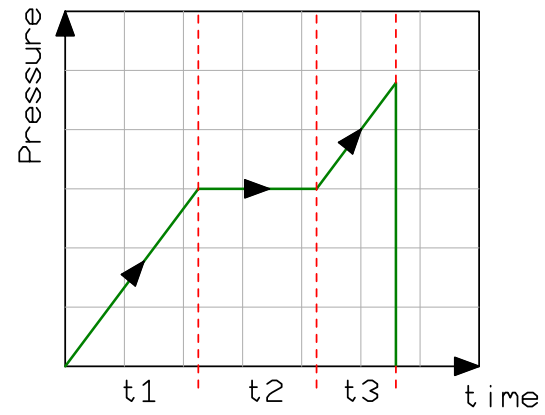

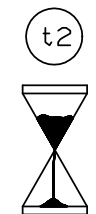
  
 Adjustable  
 stabilization  
 time

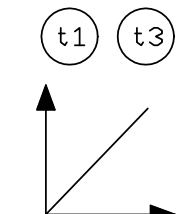
  
 Adjustable  
 slope

PRESSURE OPERATING RANGE

BASE MODEL: 150 bar

EXTENSION TO: 250 / 400 / 800 bar